

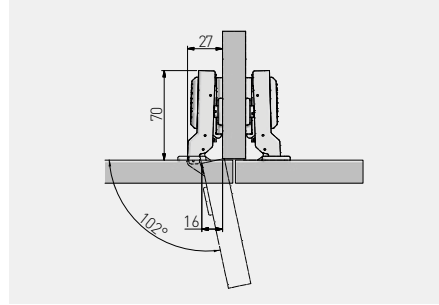





Zawias hydrauliczny ECHC, bliźniaczy  
 Hydraulic cup hinge ECHC, twin overlay door  
 Гидравлическая петля ECHC, полунакладная



					
ZM-ECHC08BEO	H=0	x 4	—	nikiel nickel	stal steel
ZM-ECHC08ZEO		x 2	x 2	никель nickel	сталь steel

